

UK Subject to change

Document Ref:
FFZ-40N/11503/PMR25/Issue 1/April 02

Copyright©
These instructions are the sole property of Ferm-Omega Tools and may not be reproduced

USER'S MANUAL

Ferm Scroll Saw

FFZ-400N

CE

Ferm[®]

Art.nr. 726290
Screwfix Art.nr. 11503

**FERM SCROLL SAW FFZ-400N
USERS MANUAL**

TECHNICAL SPECIFICATIONS

Voltage	230 V~
Frequency	50 Hz
Power consumption	90 W
Speed count w/o load/min	1440
Max saw depth 90°	50 mm
Max saw depth 45°	15 mm
Weight	15 kg
Lpa (sound pressure) w/load	62.6 dB(A)
Lpa (sound pressure) w/o load	66.4 dB(A)

PRODUCT INFORMATION

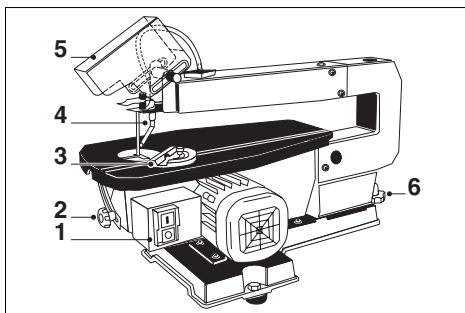

1. On/off switch
2. Locking arm
3. Cross guide
4. Dust blow pipe
5. Protective cover
6. Tensioner head

CONTENT OF THE PACKING

- 1 Scroll saw
- 1 Protective cover
- 1 Screw for installing the protective cover
- 2 Saw blades
- 2 Adapters for universal saw blades
- 2 Allen key
- 1 Dust blow pipe
- 3 Rubber feet
- 3 Screws with nuts and rings for installing the rubber feet
- 1 Cross guide
- 1 Operating manual
- 1 Safety manual
- 1 Warranty card

Check the machine, loose parts and accessories for transport damage.

SAFETY INSTRUCTIONS

The following warning symbols are used in this operating manual:

 *Danger of fatal injury and possible damage to the machine if the instructions in this manual are not observed.*

 *An electric current is present.*

Carefully read this operating manual before commissioning the machine. Acquaint yourself with its function and operation. Maintain the machine in accordance with the instructions so that it will always work faultlessly. This manual and the accompanying documentation must be stored near the machine.

Ferm products are manufactured to high quality standards they are safe and fit for purpose at time of sale, but all tools can be dangerous if the correct precautions are not taken. Always follow these instructions, do not carry out the operation until you are sure you can do so in safety. Remember to consider the work environment for safe operation as well as safety for tool use.

 **Warning!** When using electric tools, basic safety precautions should always be followed to reduce the risk of fire, electric shock and personal injury. Read all these instructions before attempting to operate this product. Save these instructions for future reference.

**PERSONAL SAFETY
Use Personal Protection Safety Equipment**

Protect eyes with safety glasses or goggles note: the use of safety protective eyewear without the CE mark can lead to serious injury if the lens breaks. A suitable dust mask should be worn if cutting, drilling or sanding is dusty, in particular chipboard or MDF. Approved safety footwear and headgear should worn as appropriate, for example on building works or when heavy weights are involved. Wear suitable gloves and apron to protect against sparks/debris. Wear earplugs or ear defenders.

Dress properly
Do not wear loose clothing or jewellery. It can get caught in moving parts. Non-skid footwear is recommended when working out doors. Wear protective hair covering to contain long hair.

Stay alert
Watch what you are doing Use common sense. Do not operate tools when tired or after taking alcohol or prescription/ non-prescription drugs.

EXPLODED VIEW

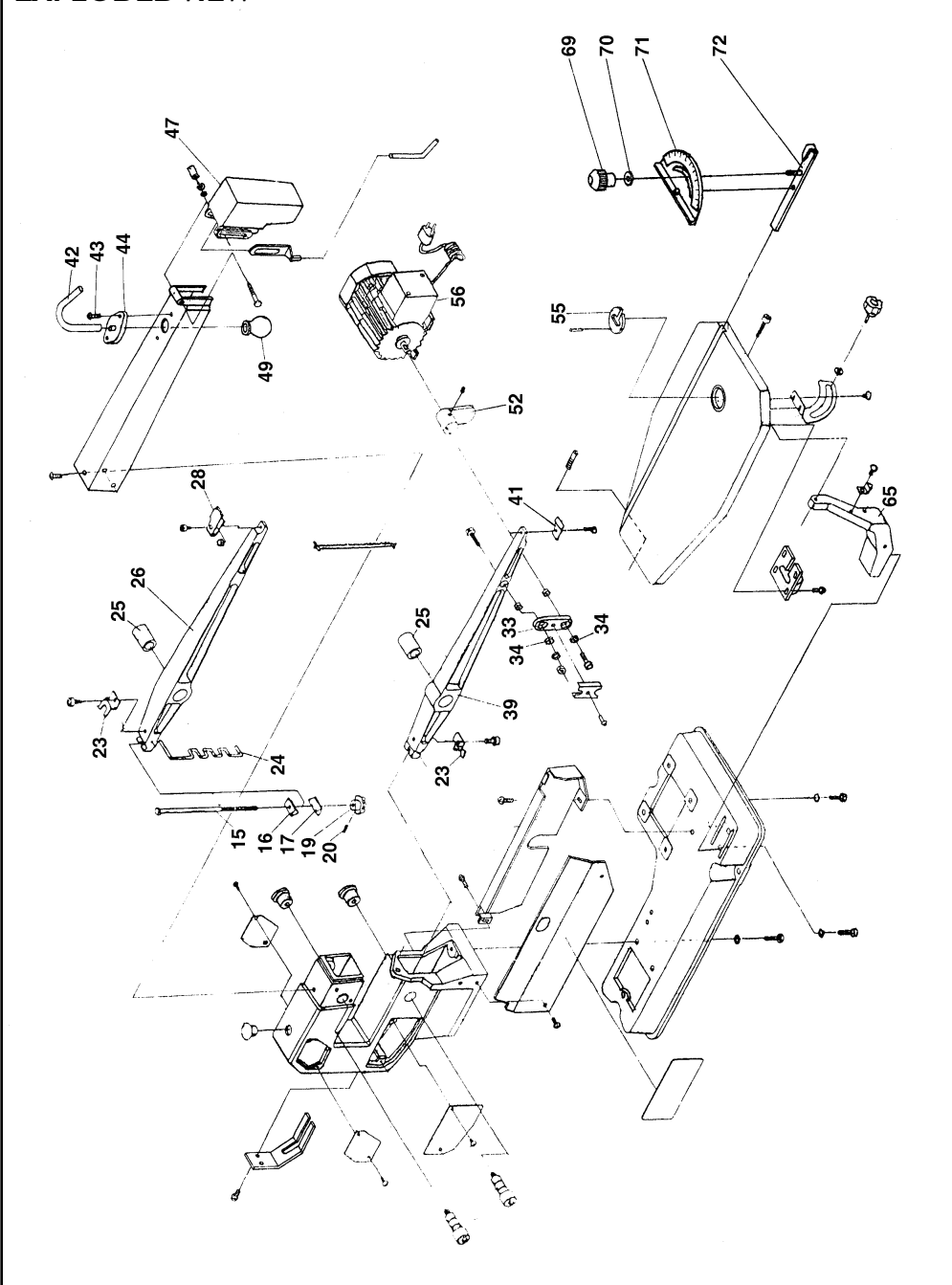

SPARE PARTS LIST FFZ-400N

REF NR	DESCRIPTION	FERM NR
015 - 020	BOLSTER THREADED COMPLETE	209860
023	PRESSING PLATE	209861
024	SPRING	209862
025	BUSHING	209863
026	UPPER ARM	209864
028	SAW BLADE HOLDER (UPPER)	209865
033 + 034	CONNECTION PLATE + BEARING	209866
039	LOWER ARM	209867
041	SAW BLADE HOLDER (LOWER)	209868
042 - 044	AIR HOSE + PLASTIC PLATE	209869
047	TRANSPARENT GUARD	209870
049	GAS BAG	209871
052	CAM	209872
055	TABLE INSERT	209873
056	MOTOR	209874
065	SUPPORT FRAME	209875
069 - 072	MITRE GUIDE COMPLETE	209876
	SWITCH	209877

OPERATIONAL SAFETY



Warning!

This machine can produce fine dust, which is harmful to your health. Always wear a suitable dust mask and other protection equipment as appropriate.

Concentrate

Routine and repetition can lead to mistakes. Remember that a slight lack of concentration can result in serious injuries in a split second.

Keep work area clean

Cluttered areas and benches invite injuries.

Consider the work environment

Do not expose power tools to rain or use them in damp or wet locations. Keep work area well lit. Do not use power tools in the presence of flammable liquids, vapours or gases.

Guard against electric shock

This unit contains dangerous voltages. Use a RCD (residual current device) to provide protection against electrical shock. Prevent body contact with grounded surfaces (e.g. pipes, radiator, ranges or refrigerators).

Keep children and pets away

Do not let children or pets come into contact with the tool, extension cable or work area.

Do not force the tool

It will work better and safer at the rate for which it was intended.

Use the right tool

Do not force small tools or attachments to do the job of a heavy-duty tool. Do not use tools for purposes for which they were not intended; for example do not use a circular saw for cutting trees or logs.

Do not abuse cable

Never carry the tool by the cable or pull it to disconnect it from the power socket. Keep the cable away from heat, oil and sharp edges. Do not touch the metal plug pins when connecting or removing the plug.

Do not over-reach

Keep a proper footing and balance at all times.

Disconnect tools from power supply

When not in use, before servicing and when changing accessories such as blades, bits and cutters.



Always switch off and unplug the saw from the power supply before making adjustments or changing blades.

Remove adjusting keys and wrenches

Ensure that they are removed from the tool before switching on.

Avoid unintentional starting

Do not carry plugged in tools with your finger on the switch. Check that the switch is off before plugging in to socket.

Connect a dust extraction device

Whenever there are facilities for fitting a dust of fume extraction system, make sure it is connected and used.

Use recommended accessories

The use of any other accessory or attachment other than recommended in the instructions or catalogue may present a risk of personal injury. Use extension cables suitable for the power input of the saw (minimum cable size 1.5mm²). When using a cable reel unwind the cable fully.

BEFORE USING THE SAW



The saw is for bench use only. Do not use outdoors.

- This saw is intended for use on wood, wood derived products, plastics and soft materials/metals.
- The saw should be placed on a level stable non-slip surface; the rubber feet (supplied) must be fitted and secured with the bolts/washers through the three holes in the footplate.
- Route the mains cable well away from the saw, ensure that it cannot get caught in moving parts or the workpiece.

ASSEMBLING THE ACCESSORIES



Make sure the saw is switched OFF and unplugged from mains.

Refer to illustration below.

Installing the saw table

- Without a blade fitted, slide rear lug on the underside of the table onto the pivot pin in the saw casing. Make sure the quadrant bracket is inside the indicator arrow.
- Put the short hexagon headed bolt through the front lug on underside of table and tighten with suitable spanner. The table should be secure but free to rotate.
- Put the thumbscrew through the curved slot in the quadrant and into the threaded hole in the saw casing - tighten by hand at the desired angle.

Installing the safety shield and dust blower

- Push the air blower tube with the bracket and nozzle assembled, onto the nipple on top of the front of the saw arm.
- Put the safety shield onto the saw arm as illustrated then push the long hexagon bolt, remove the C clip (A), through the safety shield and hole on saw arm. Reinstall the C clip on bolt on outside of shield, then put the slotted bracket of the dust blower assembly onto the bolt end and install the washer and thumbnut, tighten in the desired position.

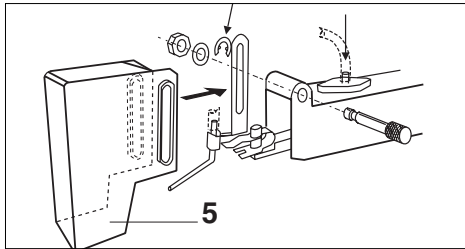

Installing the cross guide/fence

The guide (3) acts as a fence and bevel guide.

- Slide the guide into the dovetail on the saw table as illustrated below.

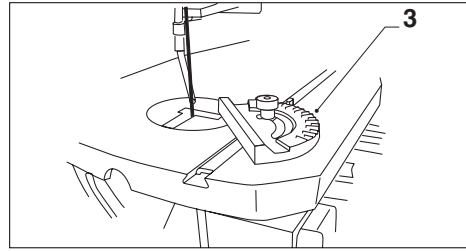

SELECTING SAW BLADES

The saw is intended for standard scroll saw/fretsaw blades nominally 125mm (5") long. Make sure you have a blade suitable for the material being cut.

- As a guide use 10 tpi (teeth per inch) for thicker material and finer 15/30 tpi for thinner material. Use thin blades when very tight curves are required.
- Use spiral or compass blades, which cut in any direction, to avoid rotating the workpiece. Check the performance of the blade on a piece of scrap before starting the job.
- There are two main types of blade fixing. Pin end and plain.
- Pin end blades are installed directly in the blade holder slot; they can be installed either in line (teeth facing forward) or at a right angle (teeth facing sideways) – see fitting blades section.
- Plain end blades use the adaptors (supplied) to fix them in the blade holder slots (facing forward only). See fitting blades section.

FITTING/CHANGING/REMOVING SAW BLADES



Make sure the saw is switched OFF and unplugged from mains.

Refer to illustration below.

When changing blades make sure that the blade slot, clamp bolts etc are free from sawdust and debris (broken/old blades).

Pin end blades

- Loosen the pivot bolt, slide the clear safety shield to its upper position and rotate it 90° towards rear of saw.
- Slack off the blade tensioner (6) at the rear of the machine.
- Insert the new blade through the slot in the saw table with the teeth facing downwards towards the saw table. Engage the pin in the lower saw blade holder.
- Pull the blade up and engage the pin in the upper blade holder.
- Tighten the tensioner to required blade tension.
- Return the clear safety shield to its operating position and adjust the dust blower nozzle.

ENVIROMENT

Recycle the packaging according to the identification marks on it.
At the end of the product or its accessories life please recycle where facilities exist. Phone the Helpline for current advice on recycling.

Helpline

For any questions relating to operational or safety matters contact:

Ferm Customer Helpline on: **0115 966 1199**
Monday-Friday **8am – 6pm**
Saturday **9am – 1 pm**

GUARANTEE

The guarantee conditions can be found on the separately enclosed guarantee card.

CE DECLARATION OF CONFORMITY (UK)

As sole responsible party, we declare that this product corresponds to the following norms or normative documents:

**EN61029-1, EN55014-1, EN55014-2,
EN61000-3-2, EN61000-3-3**

in accordance with the stipulations of the guidelines:

**98/37/EEC
73/23/EEC
89/336/EEC**

as from 01-09-2000
GENEMUIDEN NL
W. Kamphof
Quality department



Plain end/spiral blades

- Remove the three screws and the cover on the left side of the saw.
- Insert the blade through the table slot and attach the adaptor to the lower end.
- Assemble the blade adaptor onto each end of the blade; tighten the Allen bolts equally with the wrench so the blade is square in the middle of the adaptor. Ensure the small lugs on the adaptor barrel facing inwards towards the middle of the blade; these lugs locate in the depressions on the blade holders.
- Make sure the saw teeth face downwards towards the saw table.
- Locate the lower adaptor in the lower blade holder then pull the blade upwards and locate the upper adaptor in the upper blade holder.
- Reinstall the left side cover and tighten screws.
- Adjust blade tension (6), safety shield and dust blower.

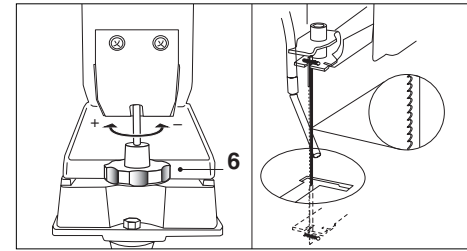

ADJUSTING THE ANGLE OF THE SAW TABLE



Do not use this machine without the table mounted.



Ensure the saw is switched OFF and unplugged from mains.

Refer to illustration.

- Loosen the quadrant thumbscrew and tilt the table to required angle.
- Tighten thumbscrew securely.

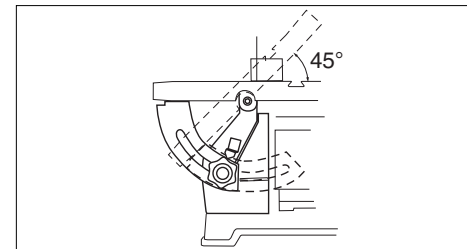

THE DUST BLOWER

The saw has a dust blower to clear sawdust / debris from the table during use.



*Be aware the saw can produce fine dust, which may be hazardous to your health.
Always wear appropriate personal protection equipment. A suitable dust mask and goggles are essential.*

USING THE SAW

BEFORE OPERATING

- Check the voltage on the saw corresponds with your power supply voltage and that the plug and lead are in good condition.
- Check you have the correct type of saw blade for the machine and that it is mounted correctly. Do not use parts other than supplied with the machine to make the blade fit properly.
- Check you have a blade suitable for the material being cut and that it is in good condition.
- Run idle for 30 seconds - if there is any abnormal vibration or other fault – switch off, inspect and rectify before continuing

OPERATION

Plug into a suitable mains supply and switch on. Refer to illustration (1).

To switch the saw ON

Push in the green button.

To switch OFF

Push in the red button.

Note: This saw has an NVR (no volt release) switch and will automatically switch off if the mains supply is interrupted or disconnected.

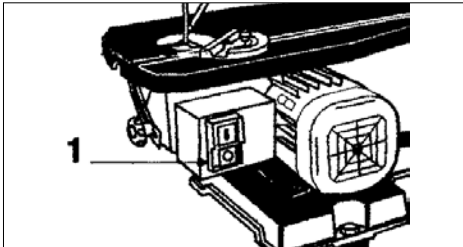

CUTTING

- Place the workpiece on the table without the blade touching it and switch ON.
- Using gentle pressure, move the saw along the line of cut, keep the workpiece in firm contact with the table. The blade cuts on the downward stroke only
- Let the saw do the cutting, undue pressure will overload the saw resulting in overheating and broken blades.
- When the cut is finished, switch off and withdraw the workpiece when the blade has stopped moving.

DURING USE

- Push the workpiece gently onto the blade.
- Tight radius cuts require narrow saw blades.
- Check material for foreign bodies. For example check for pins, nails screws etc.
- Apply suitable lubricant, when cutting metal.
- Do not use water as a lubricant/coolant.
- Keep the workpiece on the surface of table.
- Use constant gentle pressure.

- If the blade seizes in the cut, switch off and open the cut with a suitable tool before pulling the blade out. Never switch the saw on with the blade jammed.
- Regularly inspect the blade during use (switch off first) for signs of damage or wear and replace when required.
- Switch the machine off before removing the plug from the mains socket.
- Be careful. Keep your hands away from the blade.

MAINTENANCE, CARE AND REPAIR



Switch off and unplug the machine before carrying out any cleaning, adjusting or changing blades.

CLEANING

Do not use flammable liquids to clean the saw, they will damage the casing and are a fire risk. Clean with a soft brush or a cloth moistened with soapy water. Dry off afterwards.

FAULTS

Switch OFF immediately at the mains plug and remove the plug when:

- The plug or cable is damaged.
- The switch on the machine is defective.
- The motor runs hot.
- You smell or see smoke caused by scorched insulation in the machine.

The saw overheats

- Use less pressure
- Clean ventilation slots
- Defective motor.

Take to your Ferm dealer.

The saw does not work when switched on

- Damaged/faulty plug.
Switch or power lead, take to your Ferm dealer for repair.

The saw wanders off the cut line

- Worn or bent blade.
Replace blade.

The saw makes a lot of noise and does not run smoothly

- The carbon brushes are worn.
Take to your Ferm dealer for replacement.

There are no user serviceable/repairable parts in this unit. Qualified service engineers must carry out repair and servicing.

MAINTAIN TOOLS WITH CARE

Keep the tool clean for better and safer performance. Store the blades properly in accordance with the maker's instructions. Follow instructions for changing accessories. Inspect tool and extension cables periodically and if damaged, have them repaired by a qualified person or authorised service body. Keep handles free from oil or grease. Keep the ventilation slots clean to prevent the motor overheating.

Check for damaged parts

Do not use a tool with damaged parts, before further use a damaged tool must be carefully checked by a qualified person to determine that it will operate properly. Check for alignment of moving parts, binding or breakage of parts, mounting and other conditions that may affect its operation.

A damaged part or guard should be properly repaired by an authorised service centre, unless indicated otherwise in the instruction manual. Have defective switches replaced by an authorised service centre. Do not use a tool if the switch does not turn on and off.

Have your tool repaired by an expert

This appliance is manufactured in accordance with relevant safety standards. Only experts must carry out repairing of electrical appliances, otherwise considerable danger for the user may result.

Storing tools

When not in use tools should be stored in the dry, out of reach of children.

Lubrication

The machine does not require user lubrication.

ELECTRICAL INFORMATION

This product is complete with a pre-wired mains plug. If the plug needs replacing follow these instructions.

Wire correctly

The wires in the mains lead are coloured in the following way:

- | | |
|--------------|----------------|
| BLUE | • Neutral |
| BROWN | • Live |
| EARTH | • Yellow/Green |

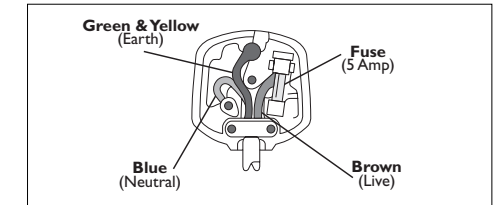

Securing wires

Secure wires carefully and firmly to the correct terminals. Secure the mains cable in the plug cord grip firmly. Fit a 5-amp fuse. If a 13amp (BS1363) plug is used a (BS1362) ASTA approved 5-amp fuse must be fitted. If in doubt always consult a qualified electrician.

Recycle/Dispose of old plug and cable

Prevent inadvertent connection to socket and risk of electric shock.